

Let's make it happen – AMI, IoT and Big Data Collection

Company Background



Who are we?

- an R&D company;
- specialise in standards-based communications technology;
- facilitate data communication in AMI/IoT
- target utility industry, energy monitoring, water supply monitoring and IoT system solution for agriculture;
- with cross-field expertise in ICT, electrical & electronic engineering;
- in the industry since 2006;

Head office and R&D Office



Zodicom

zodicom@zodicom.com

Head Office
Room 213-224
2/F Sino Industrial Plaza
9 Kai Cheung Road
Kowloon
Hong Kong
☎ +852 28328228



Research & Development Office
11 Tannery Road
Marshall VIC 3216
Australia
☎ +61 3 9016 3807



Flickr: LanceCheungImages

Our Products



Why Zodicom Products?

- reliable (track record of a near 100% rate);
- interoperable;
- secure;
- scalable;
- customisable;
- highly cost competitive;
- best practice conscious;



Key Benefits to You

- Systems stability;
- Operational efficiency;
- Cost savings;
- Effective infrastructure planning;
- Market differentiation;

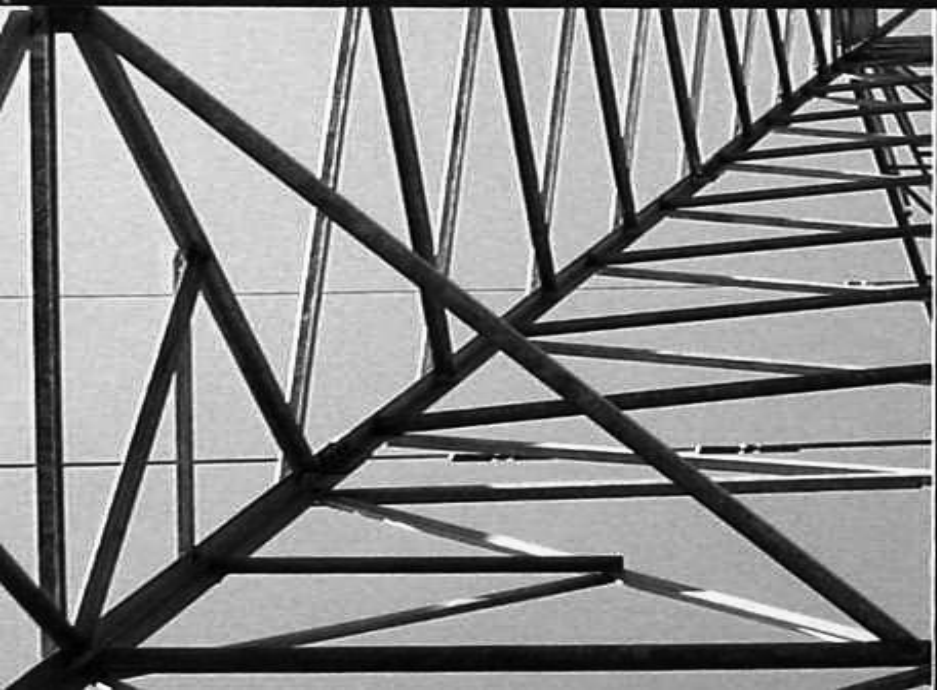
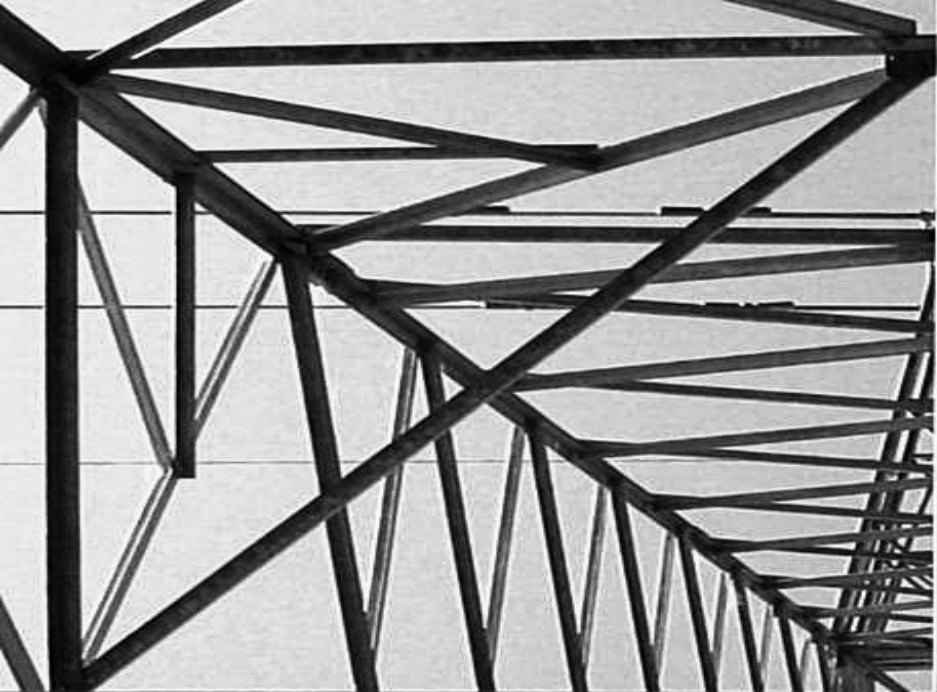

Product Lineup



Beauty Shots



ZM6280



ZM2300G



ZM6380



ZM2385



ZM2380

Product List

Products	Model No
Data Concentrator Unit (Basic Unit)	ZM6380
Data Concentrator Unit with 3G/LTE 4G Modem	ZM6380M
Data Concentrator Unit with Short Range RF Module	ZM6380R
Data Concentrator Unit with Wi-Fi Module	ZM6380W
Data Concentrator Unit with 3G/LTE 4G & Short Range RF Module	ZM6380GR
GPRS/3G modem for Elster A1700 meter	ZM2380
GPRS/3G with Short Range RF for Elster A1700 meter	ZM2380R
Short Range RF module for Elster A1700 meter	ZM6280
Power Adapter Unit for Elster A1700 meter	PS1700G
3G/LTE 4G modem for AS230, AS3500 meter	ZM2300G
RS232 to RS485 converter for A1120 and A1140 meter	ZM2385
M-Bus Master with LoRa wireless communication module	ZM3320
Data Concentrator with LoRa and 4G module	ZM3380
Wireless IoT system for Water Consumption Monitoring	ZM3300



Product Applications

Zodicom AMR System Solutions

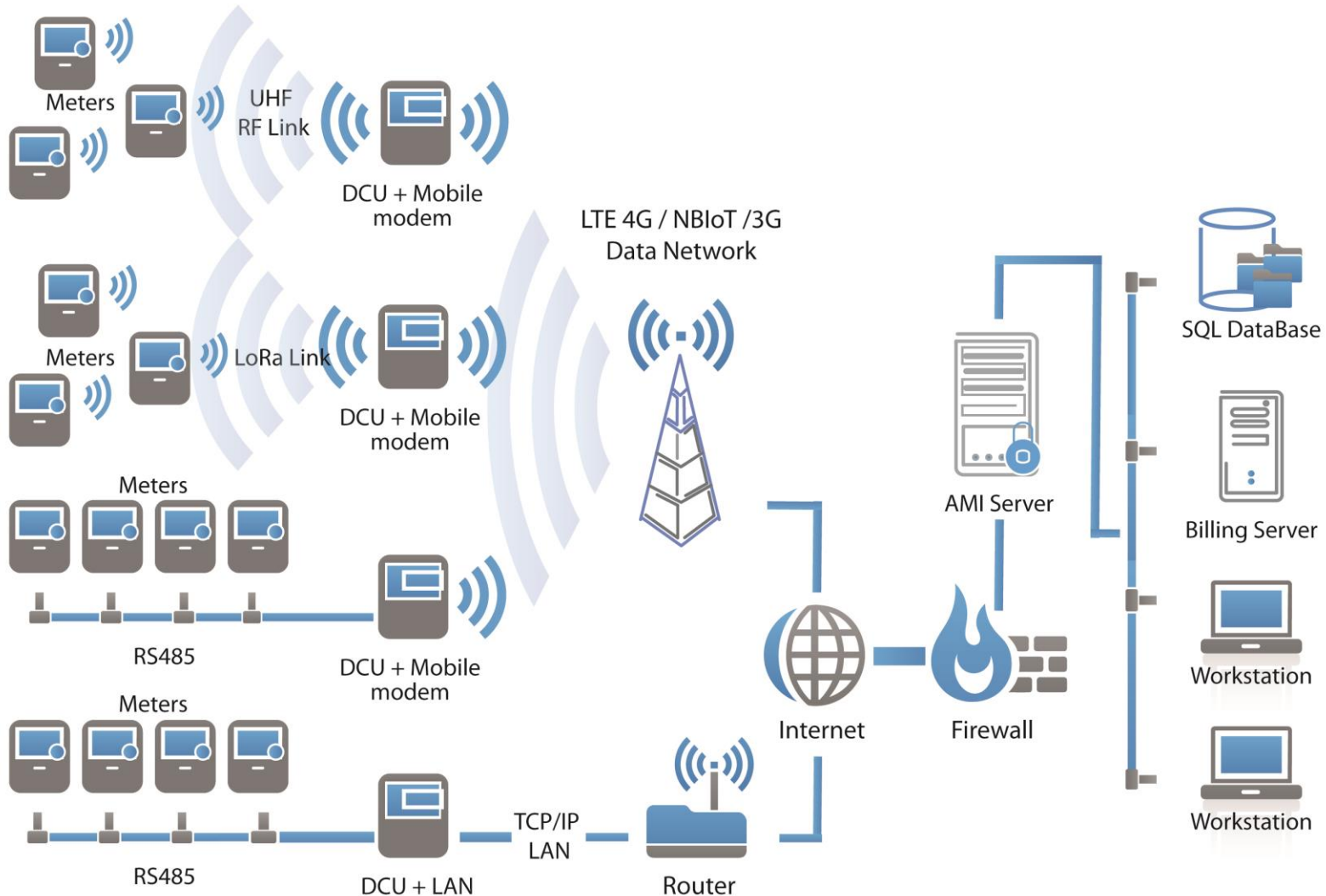

ZM6380 DCU

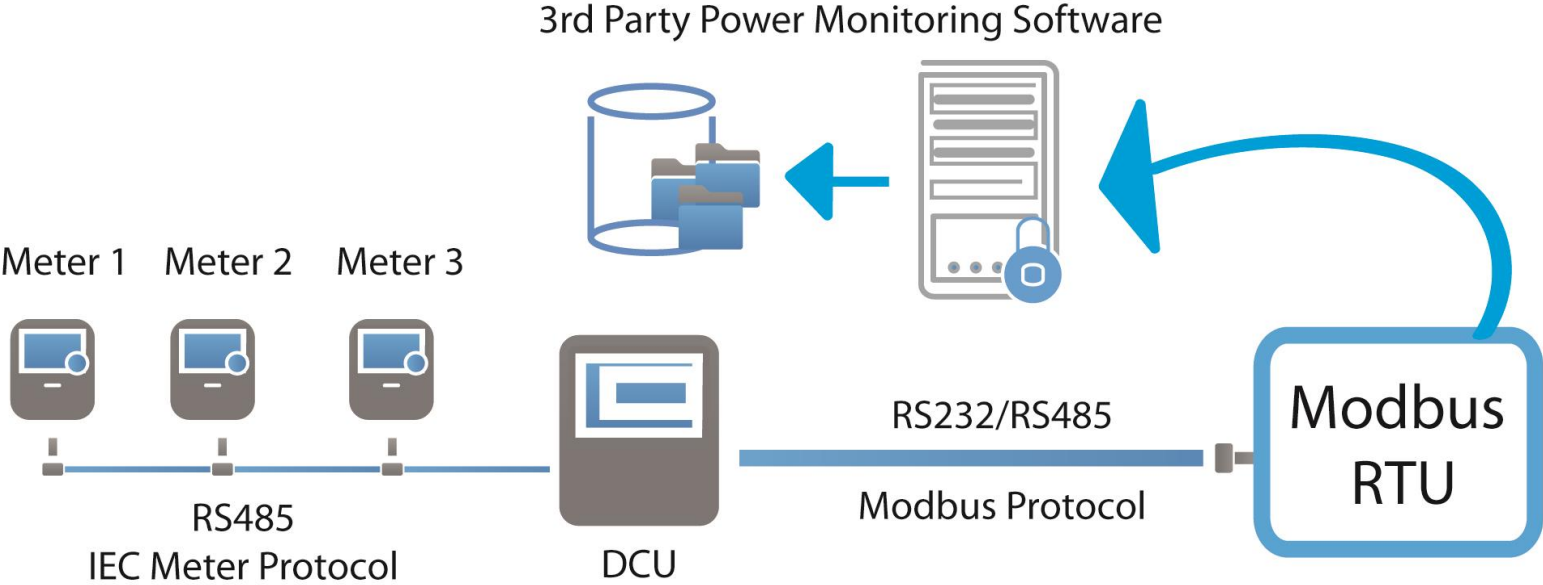

ZM6280 Short Range RF modules and ZM2380R 3G modem Solution

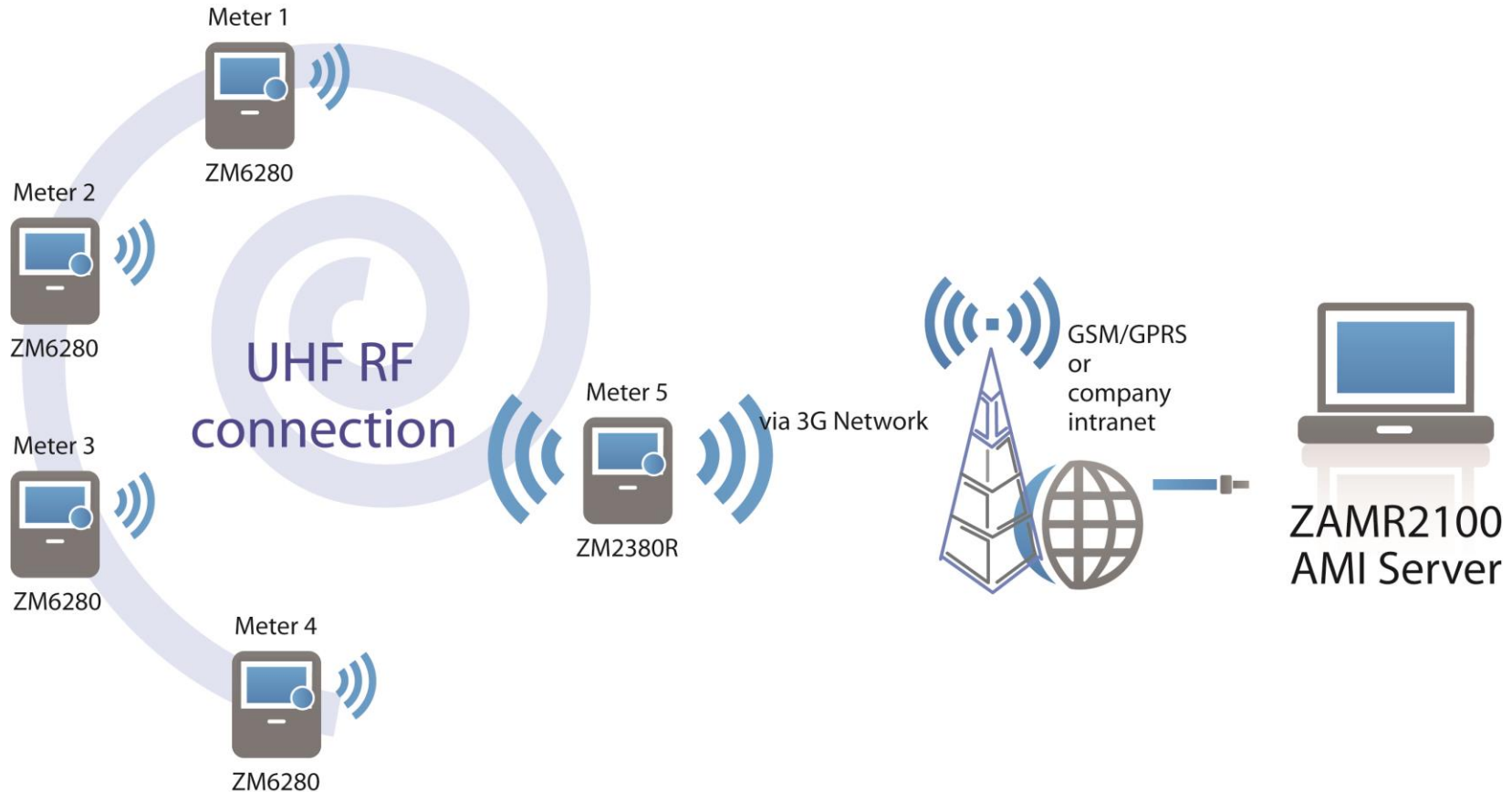



Project Experiences

Our Experience – AMR System

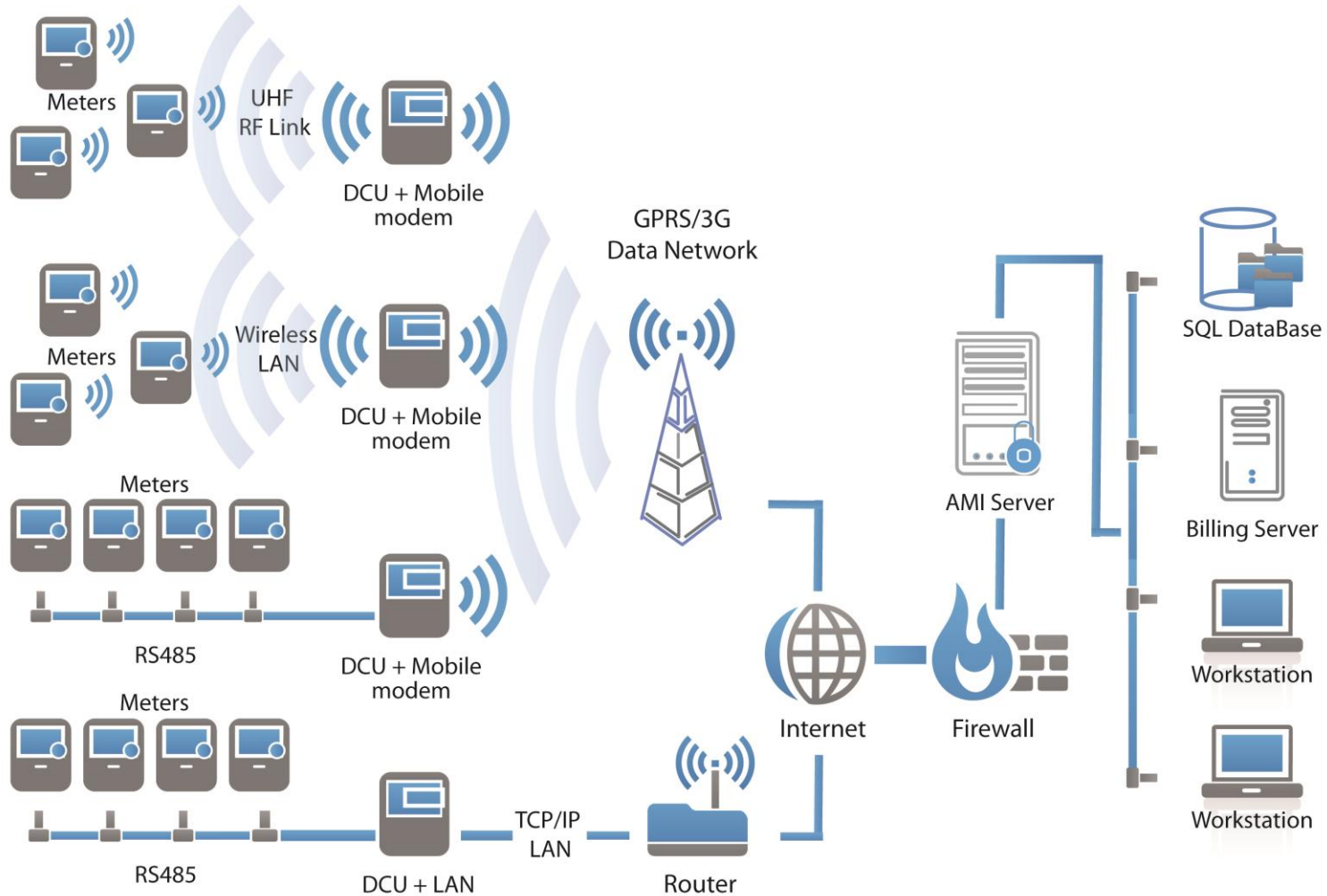

Our Experience – EVQC payment system

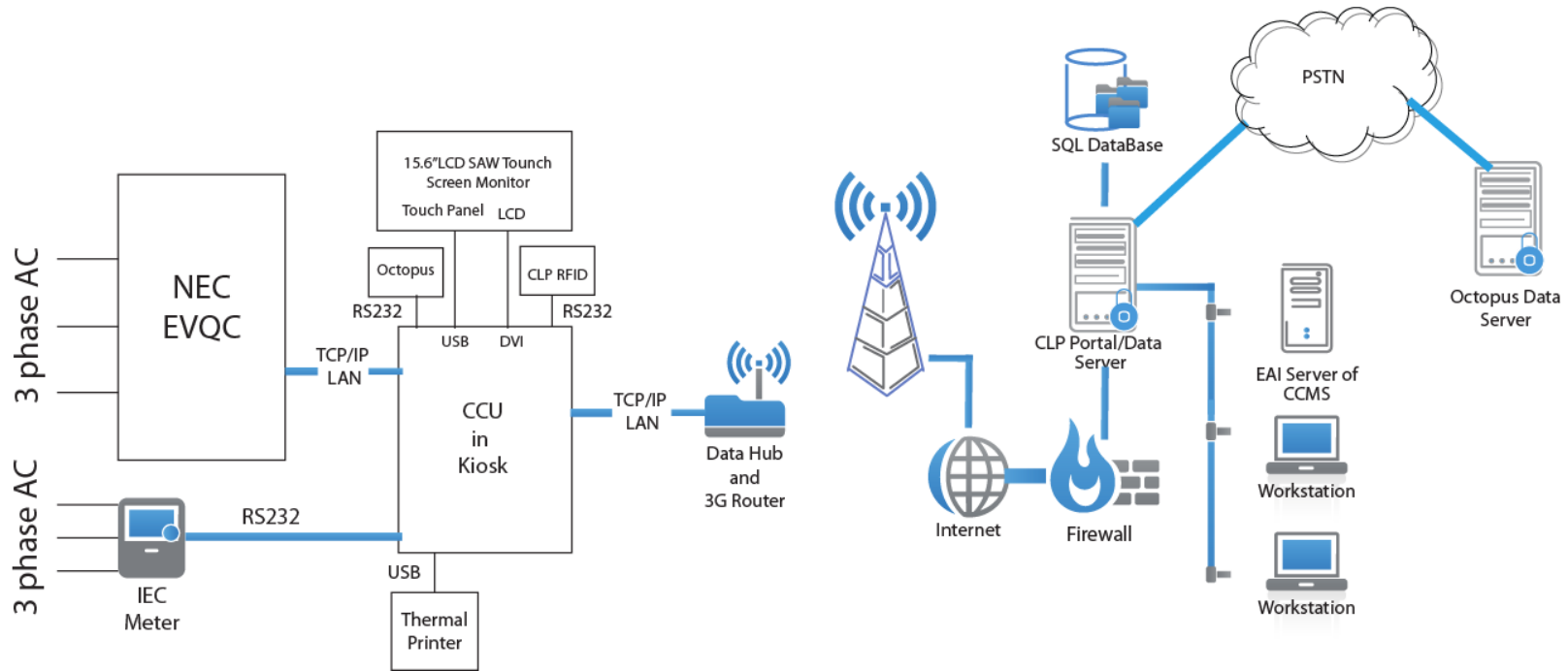



Zodicom's Customers



Our Customers

- **Utilities in Hong Kong**
- **Electrical Energy Meter suppliers**
- **Properties management service suppliers**
- **Energy Monitoring System service suppliers**
- **IoT system integrators**



Sites our product installed

High-rise Building AMR



ZM2385 inside Elster meters

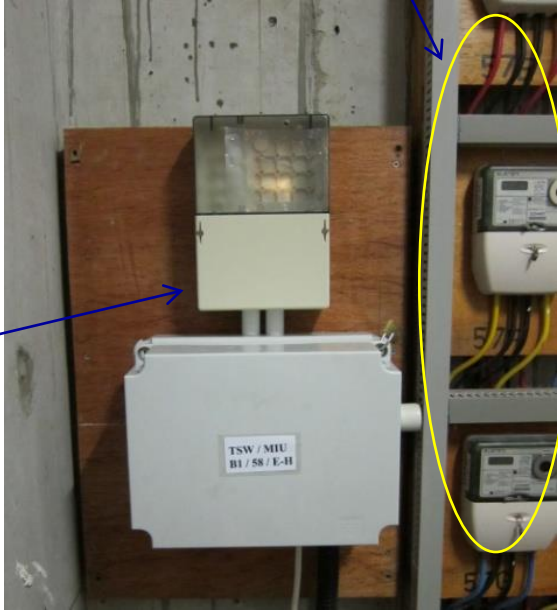

ZM6380G



Switch Room Installation

ZM6380G



ZM2385 inside
Elster meters

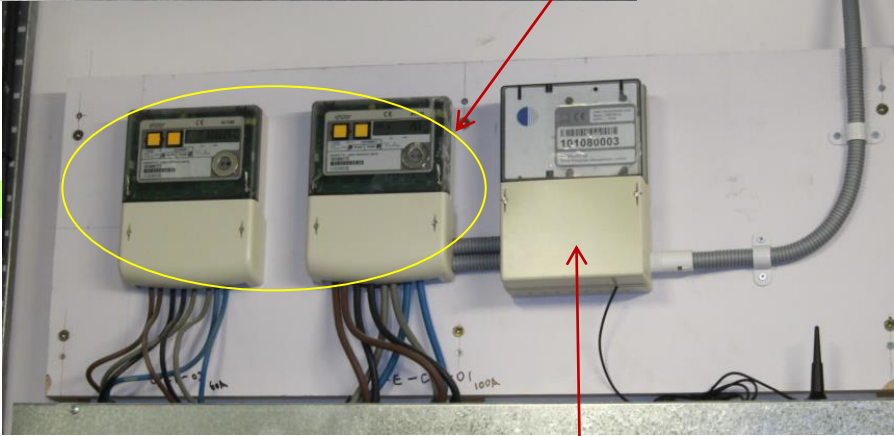
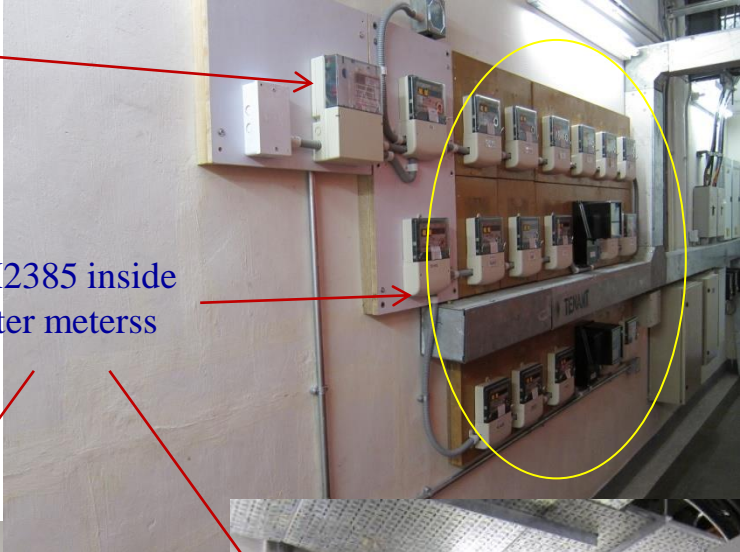

ZM6380G



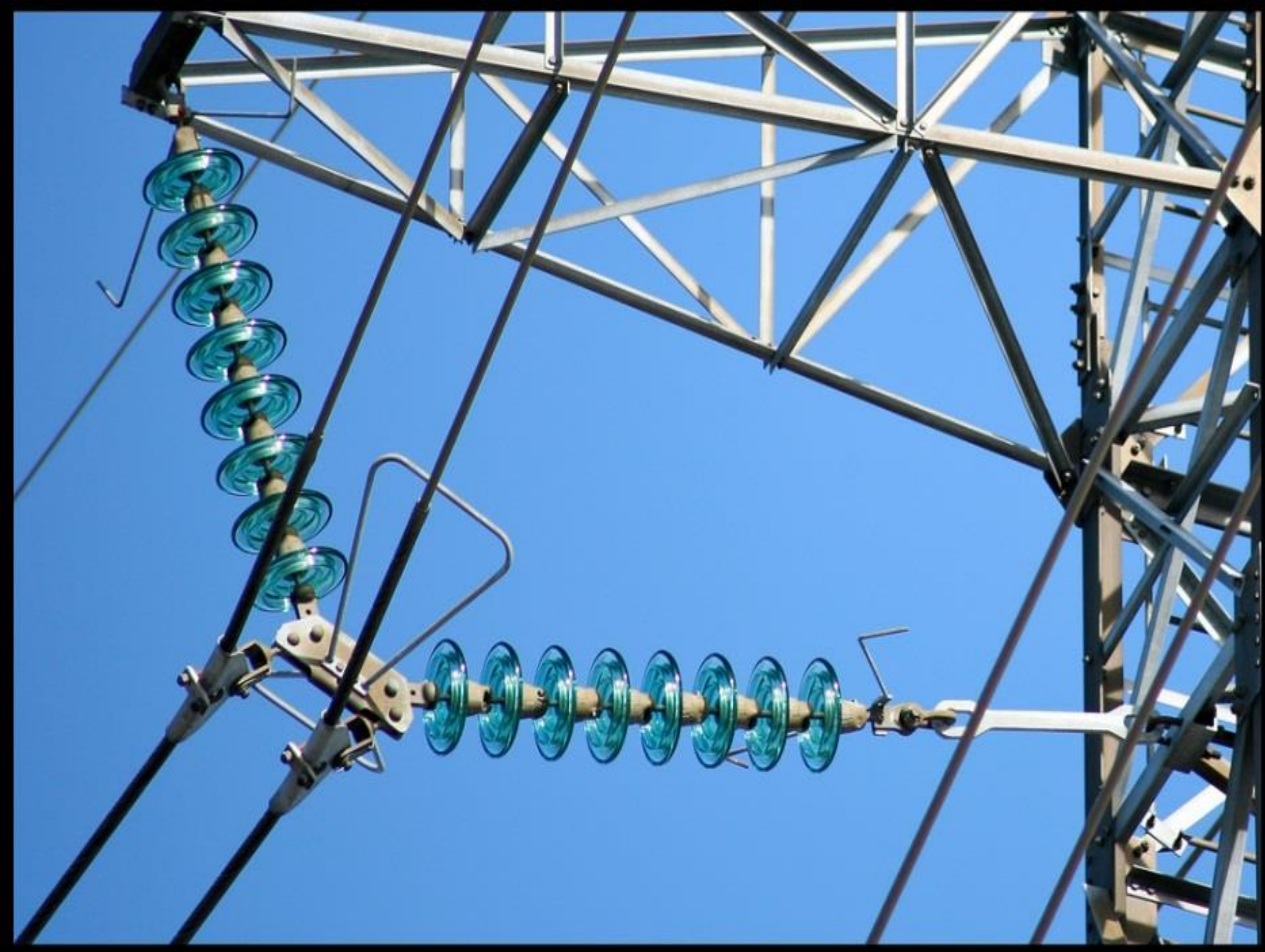

Summary

A Recap

Reliable, scalable/customisable, secure and interoperable AMI solutions

- Building on years of multidisciplinary expertise;
- Proven project experiences in AMI solutions in electricity industry;
- Products been in use since 2005;

Market-ready solutions

- Products immediately available;

Highly cost effective products

- reasonably priced solutions;

A Recap

Comprehensive range of seamless turn-key AMI system solutions

GSM/GPRS modem, 3GPP HSPA modem, 4G LTE modem, IoT system using LoRa and M-Bus for Water consumption Monitoring, 409-410 MHz or 433 MHz short-range RF communicator, RS485 to RS232 converter, Data Concentrator Unit.

Rich Experiences in System design

- Experiences in system design of Automatic Meter Reading (AMR) System, Electric Vehicles Quick Charging Station (EVQC) payment system and other Internet of Things (IoT) application design

Keeping you ahead of competition

- Cost savings & efficiency, green credential, customer relations, etc.

Thank you!





**RM 13-24, 2/F Sino Industrial Plaza, 9 Kai Cheung Road, Kowloon, Hong Kong.
Email: zodicom@zodicom.com**